

Features

- Fast turn-off thyristor
- Fast recovery diode
- High surge capability
- Electrically isolated baseplate
- 3000 V_{RMS} isolating voltage
- Industrial standard package
- UL E78996 approved 

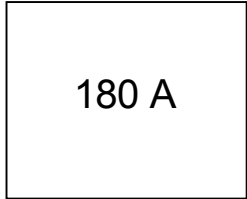

Description

These series of MAGN-A-pak modules are intended for applications such as self-commutated inverters, DC choppers, electronic welders, induction heating and others where fast switching characteristics are required.

Major Ratings and Characteristics

Parameters	IRK.F180..	Units
I _{T(AV)}	180	A
@ T _C	85	°C
I _{T(RMS)}	400	A
I _{TSM} @ 50Hz	7130	A
@ 60Hz	7470	A
I ² t @ 50Hz	255	KA ² s
@ 60Hz	232	KA ² s
I ² √t	2550	KA ² √s
t _q	20 and 25	μs
t _{rr}	2	μs
V _{DRM} /V _{RSM}	up to 1200	V
T _J range	-40 to 125	°C

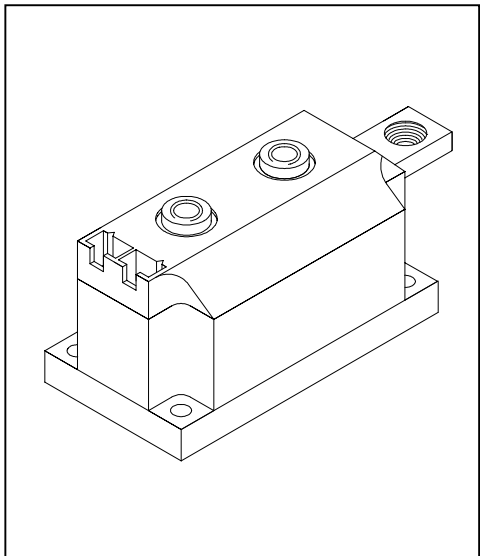

IRK.F180.. Series

Bulletin I27100 rev. C 03/01

International
IR Rectifier

ELECTRICAL SPECIFICATIONS

Voltage Ratings

Type number	Voltage Code	V_{RRM}/V_{DRM} maximum repetitive peak reverse voltage V	V_{RSM} , maximum non-repetitive peak rev. voltage V	I_{RRM}/I_{DRM} max. @ $T_J = 125^\circ\text{C}$ mA
IRK.F180-	08	800	800	50
	12	1200	1200	

Current Carrying Capacity

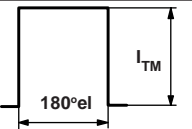
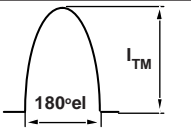
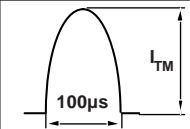
Frequency f							Units
	I_{TM}	I_{TM}	I_{TM}	I_{TM}	I_{TM}	I_{TM}	
50Hz	370	530	565	800	2400	3150	A
400Hz	435	650	670	1000	1540	2050	A
2500Hz	290	430	490	720	610	830	A
5000Hz	240	345	390	540	390	540	A
10000Hz	170	270	290	390	-	-	A
Recovery voltage Vr	50	50	50	50	50	50	V
Voltage before turn-on Vd	80% V_{DRM}		80% V_{DRM}		80% V_{DRM}		V
Rise of on-state current di/dt	50	50	-	-	-	-	A/ μs
Case temperature	85	60	85	60	85	60	$^\circ\text{C}$
Equivalent values for RC circuit	10 Ω /0.47 μF		10 Ω /0.47 μF		10 Ω /0.47 μF		

On-state Conduction

Parameter	IRK.F180..	Units	Conditions
$I_{T(AV)}$ Maximum average on-state current @ Case temperature	180	A	180° conduction, half sine wave
	85	$^\circ\text{C}$	
$I_{T(RMS)}$ Maximum RMS current	400	A	as AC switch
I_{TSM} Maximum peak, one-cycle, non-repetitive surge current	7130	A	t = 10ms No voltage reappplied
	7470		t = 8.3ms 100% V_{RRM} reappplied
	6000		t = 10ms 100% V_{RRM} reappplied
	6280		t = 8.3ms 100% V_{RRM} reappplied
I^2t Maximum I^2t for fusing	255	KA ² s	t = 10ms No voltage reappplied
	232		t = 8.3ms 100% V_{RRM} reappplied
	180		t = 10ms 100% V_{RRM} reappplied
	164		t = 8.3ms 100% V_{RRM} reappplied
$I^2\sqrt{t}$ Maximum $I^2\sqrt{t}$ for fusing	2550	KA ² $\sqrt{\text{s}}$	t = 0 to 10ms, no voltage reappplied
$V_{T(TO)1}$ Low level value of threshold voltage	1.30	V	(16.7% $\times \pi \times I_{T(AV)} < I < \pi \times I_{T(AV)}$), $T_J = T_J$ max.
$V_{T(TO)2}$ High level value of threshold voltage	1.38		($I > \pi \times I_{T(AV)}$), $T_J = T_J$ max.
r_{t1} Low level value of on-state slope resistance	0.90	mW	(16.7% $\times \pi \times I_{T(AV)} < I < \pi \times I_{T(AV)}$), $T_J = T_J$ max.
r_{t2} High level value of on-state slope resistance	0.71		($I > \pi \times I_{T(AV)}$), $T_J = T_J$ max.
V_{TM} Maximum on-state voltage drop	1.84	V	$I_{pk} = 600\text{A}$, $T_J = T_J$ max., $t_p = 10\text{ms}$ sine pulse
I_H Maximum holding current	600	mA	$T_J = 25^\circ\text{C}$, $I_T > 30\text{A}$
I_L Typical latching current	1000	mA	$T_J = 25^\circ\text{C}$, $V_A = 12\text{V}$, $R_a = 6\Omega$, $I_g = 1\text{A}$

Switching

Parameter	IRK.F180..	Units	Conditions
di/dt Maximum non-repetitive rate of rise	800	A/μs	Gate drive 20V, 20Ω, tr ≤ 1ms, V _D = 80% V _{DRM} T _J = 25°C
t _{rr} Maximum recovery time	2	μs	I _{TM} = 350A, di/dt = -25A/μs, V _R = 50V, T _J = 25°C
t _q Maximum turn-off time	K 20	J μs	I _{TM} = 750A, T _J = 125°C, di/dt = -25A/μs, V _R = 50V, dv/dt = 400V/μs linear to 80% V _{DRM}

Blocking

Parameter	IRK.F180..	Units	Conditions
dv/dt Maximum critical rate of rise of off-state voltage	1000	V/μs	T _J = 125°C., exponential to = 67% V _{DRM}
V _{INS} RMS isolation voltage	3000	V	50 Hz, circuit to base, T _J = 25°C, t = 1 s
I _{RRM} Maximum peak reverse and off-state leakage current I _{DRM}	50	mA	T _J = 125°C, rated V _{DRM} /V _{RRM} applied

Triggering

Parameter	IRK.F180..	Units	Conditions
P _{GM} Maximum peak gate power	60	W	f = 50 Hz, d% = 50
P _{G(AV)} Maximum peak average gate power	10	W	T _J = 125°C, f = 50Hz, d% = 50
I _{GM} Maximum peak positive gate current	10	A	T _J = 125°C, t _p ≤ 5ms
-V _{GM} Maximum peak negative gate voltage	5	V	
I _{GT} Max. DC gate current required to trigger	200	mA	T _J = 25°C, V _{ak} 12V, Ra = 6
V _{GT} DC gate voltage required to trigger	3	V	
I _{GD} DC gate current not to trigger	20	mA	T _J = 125°C, rated V _{DRM} applied
V _{GD} DC gate voltage not to trigger	0.25	V	

Thermal and Mechanical Specifications

Parameter	IRK.F180..	Units	Conditions
T _J Max. junction operating temperature range	- 40 to 125	°C	
T _{stg} Max. storage temperature range	- 40 to 150		
R _{thJC} Max. thermal resistance, junction to case	0.125	K/W	Per junction, DC operation
R _{thC-hs} Max. thermal resistance, case to heatsink	0.02	K/W	Mounting surface flat and greased Per module
T Mounting torque ± 10% MAP to heatsink busbar to MAP	4 - 6 (35 - 53)	Nm (lb*in)	A mounting compound is recommended. The torque should be rechecked after a period of 3 hours to allow for the spread of the compound. Use of cable lugs is not recommended, busbars should be used and restrained during tightening. Threads must be lubricated with a compound
	4 - 6 (35 - 53)		
wt Approximate weight	500 (17.8)	g (oz)	

IRK.F180.. Series

Bulletin I27100 rev. C 03/01

International
IR Rectifier

ΔR_{thJC} Conduction

(The following table shows the increment of thermal resistance R_{thJC} when devices operate at different conduction angles than DC)

Conduction angle	Sinusoidal conduction	Rectangular conduction	Units	Conditions
180°	0.009	0.006	K/	T_J 125°C
120°	0.010	0.011		
90°	0.014	0.015		
60°	0.020	0.020		
30°	0.032	0.033		

Ordering Information Table

Device Code							
IRK	T	F	180	-	12	H	K
①	②	③	④		⑤	⑥	⑦
1	-	Module type					
2	-	Circuit configuration					
3	-	Fast SCR					
4	-	Current rating $I_{T(AV)}$	10	rounded			
5	-	Voltage code	Code	100	V_{RRM}	(See Voltage Ratings Table)	
6	-	dv/dt code	H	$\leq 400V/\mu s$			
7	-	t_q code	K	$\leq 20\mu s$			
			J	$\leq 25\mu s$			

NOTE: To order the Optional Hardware see Bulletin I27900

Outline Table

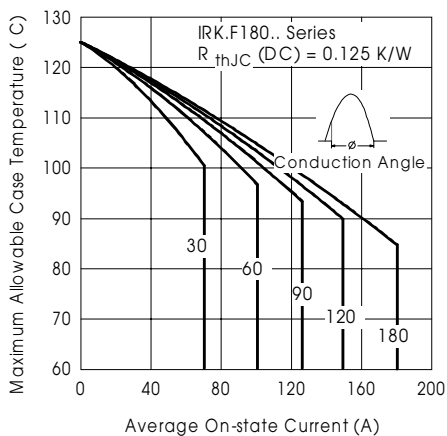
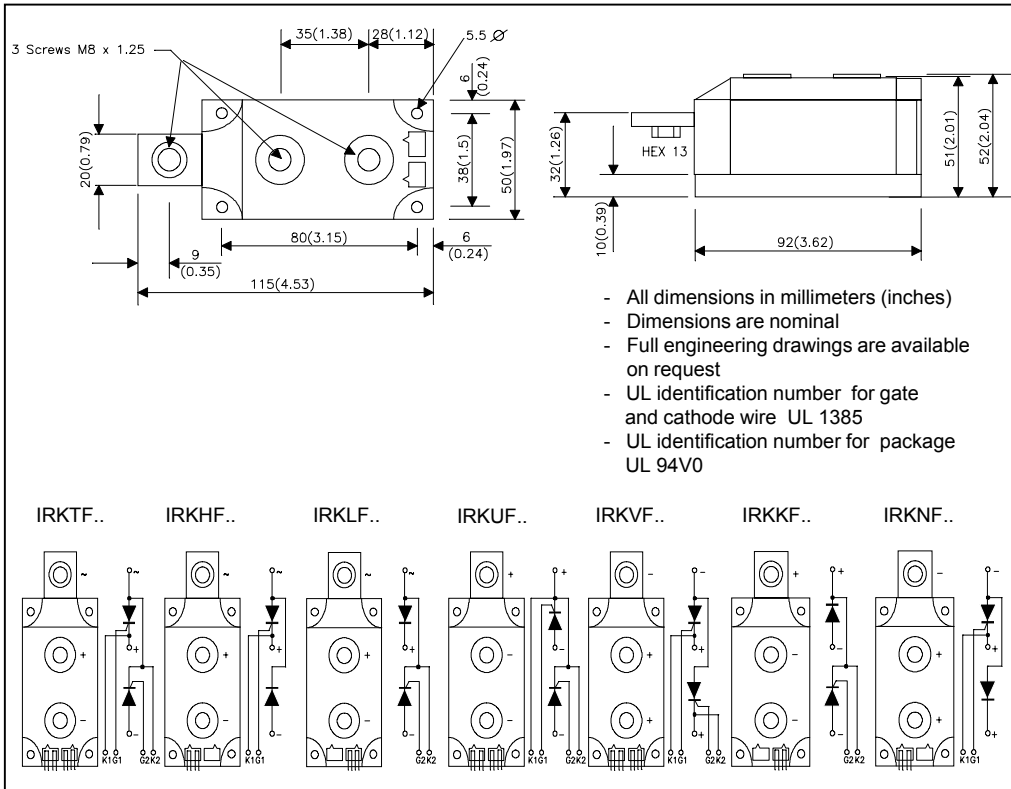

Fig. 1 - Current Ratings Characteristics

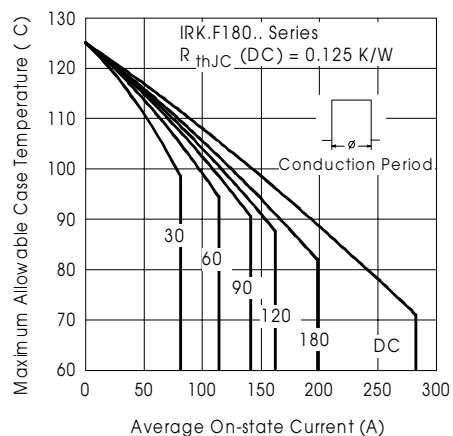

Fig. 2 - Current Ratings Characteristics

IRK.F180.. Series

Bulletin I27100 rev. C 03/01

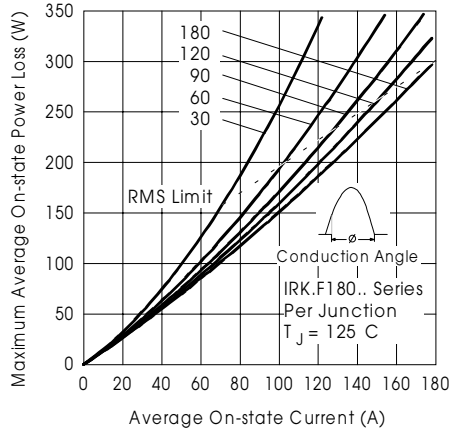

Fig. 3 - n-state Power Loss Characteristics

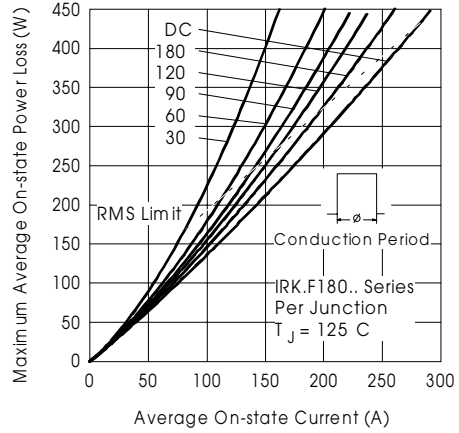

Fig. 4 - n-state Power Loss Characteristics

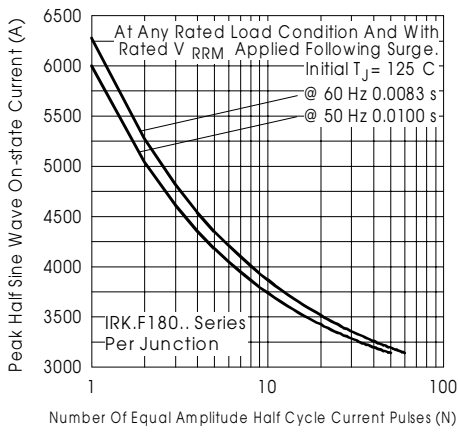

Fig. 5 - Maximum Non-Repetitive Surge Current

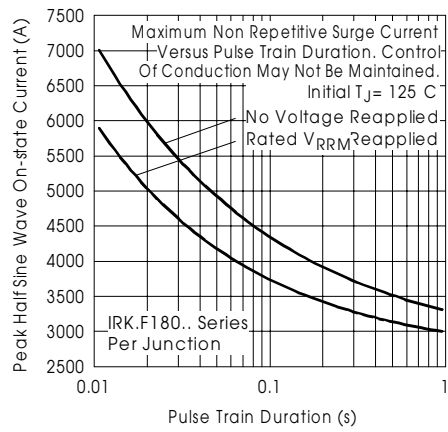

Fig. 6 - Maximum Non-Repetitive Surge Current

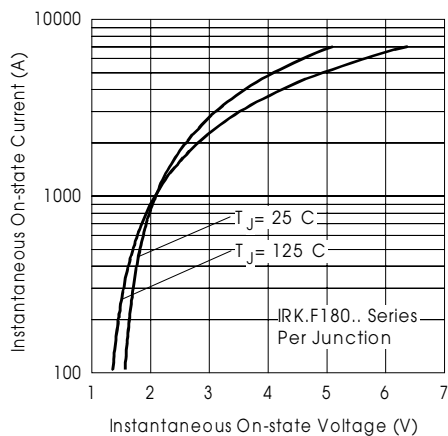

Fig. 7 - n-state Voltage Drop Characteristics

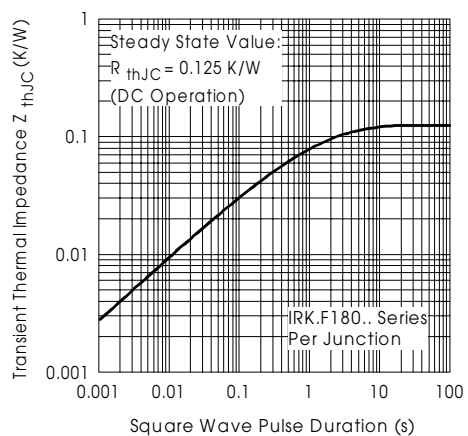

Fig. 8 - Thermal Impedance Z_{thJC} Characteristics

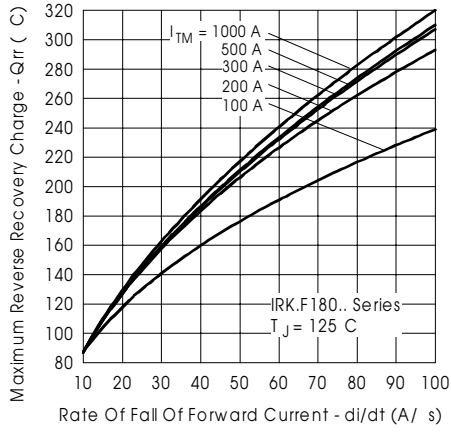

Fig. 9 - Reverse Recovery Charge Characteristics

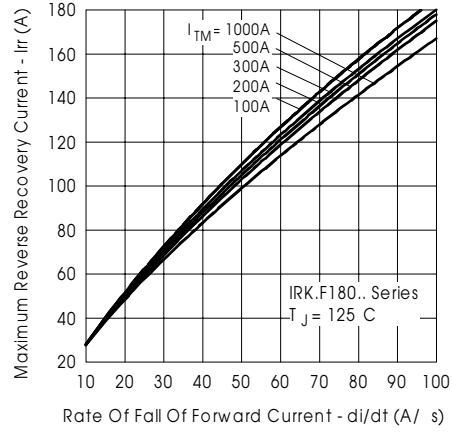

Fig. 10 - Reverse Recovery Current Characteristics

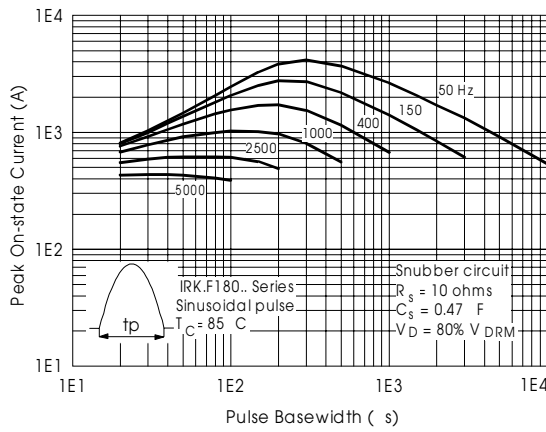

Fig. 11 - Frequency Characteristics

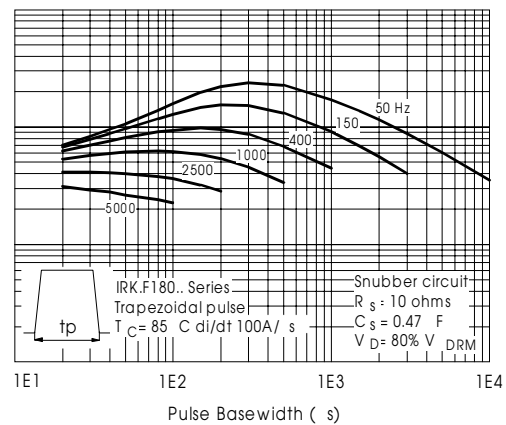
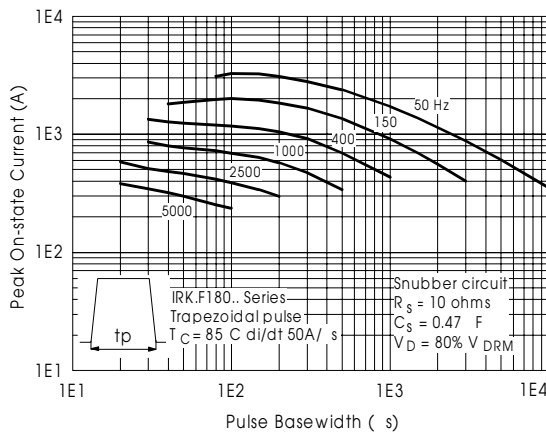
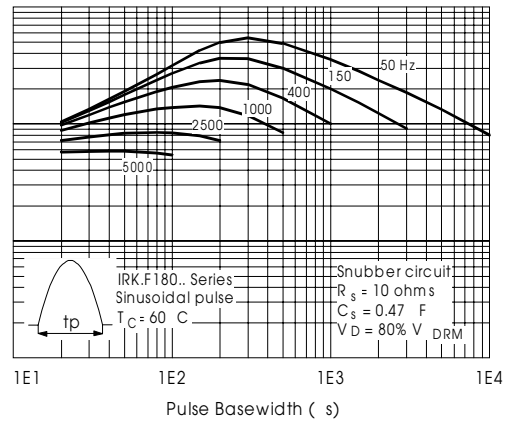

Fig. 12 - Frequency Characteristics

IRK.F180.. Series

Bulletin I27100 rev. C 03/01

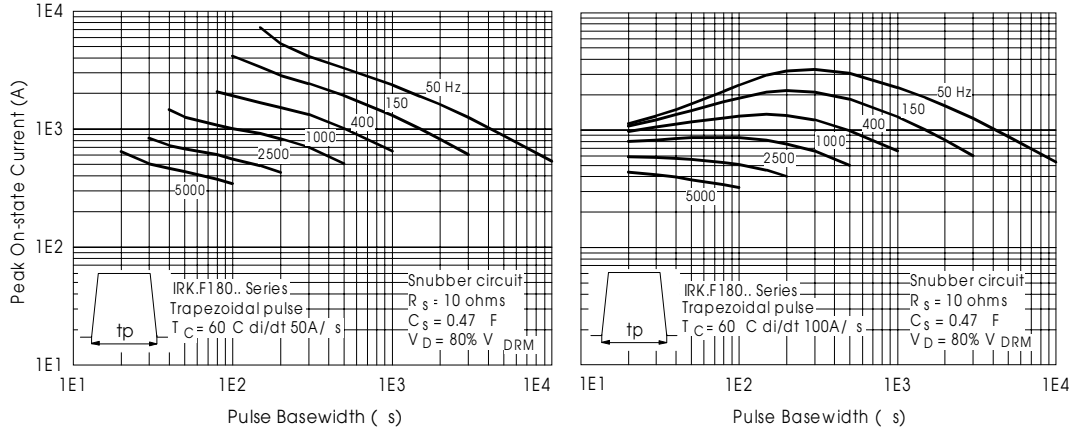

Fig. 13 - Frequency Characteristics

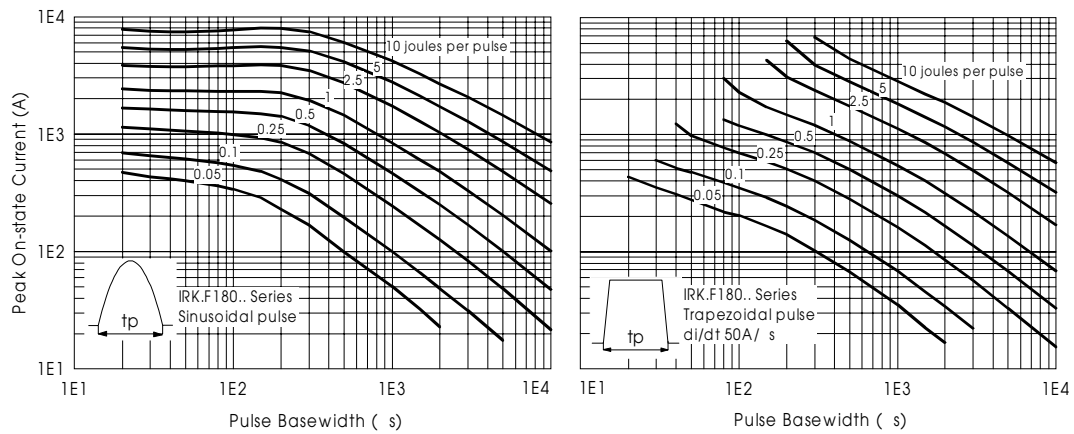

Fig. 14 - Minimum On-state Energy Power Loss Characteristics

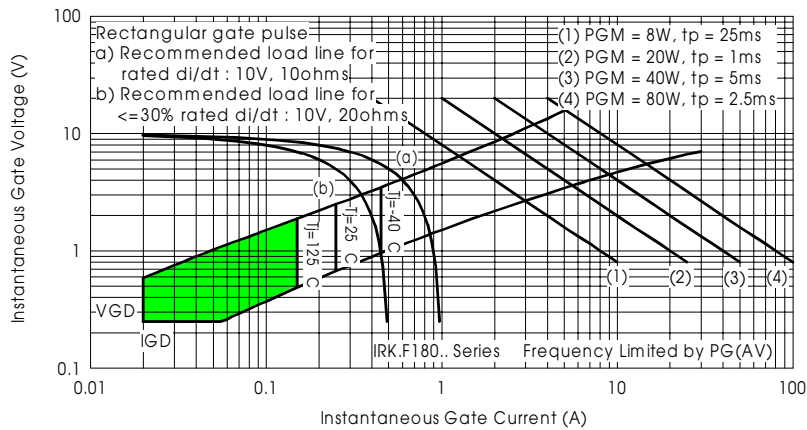

Fig. 15 - Gate Characteristics